

Features
X12 5-IN-1 AIO flight controller built-in 2.4G ELRS V2.0 and OPENVTX
VTX Power up to 400mw
ELRS V2.0 (Default), provide firmware to support ELRS V3.0
EX1103 KV110000 motors
CaddxFPV Ant FPV camera
Smooth and powerful
Compatible for 1S-2S Lipo/LIHV battery
Recommend 2S 450mah/550mah/650mah battery (Not include)

Specifications
Brand Name: Happymodel
Item Name: Mobula8 1-2S 85mm Micro FPV whoop drone
Wheelbase: 85mm
Size: 120mm*120mm*50mm
Weight: 43g

Receiver option
2.4G ELRS SPI(Support ELRS v2.0, provide firmware could compatible with elrs v3.0)
SPI Frsky D8/D16 not compatible with EMAX E6 radio
SPI Flysky AFHDS2A
PNP (without onboard receiver)
TBS version(with external TBS CRSF NANO RX)

Package includes	Qty
Mobula8 Frame	1
Option1: X12 ELRS V2.1 flight controller built-in SPI ELRS 2.4G receiver	1
Option2: X12 Frsky V2.1 flight controller built-in SPI Frsky 2.4G receiver	
Option3: X12 Flysky V1.0 flight controller built-in SPI Flysky 2.4G receiver	
Option4: X12 PNP V1.1 flight controller without onboard receiver	
Option5: X12 PNP V1.1 flight controller with TBS CRSF NANO RX	
EX1103 KV11000 brushless motor	4
Gemfan Hurricane 2023 tri-blade propellers(4cw+4ccw)	1
Caddx ANT 1200TVL Camera	1
Onboard 5.8G Openvtx 0mw-400mw VTX	1
Canopy for 14mmx14mm camera	1
Screw driver	1

### FLIGHT CONTROLLER CONNECTION DIAGRAM

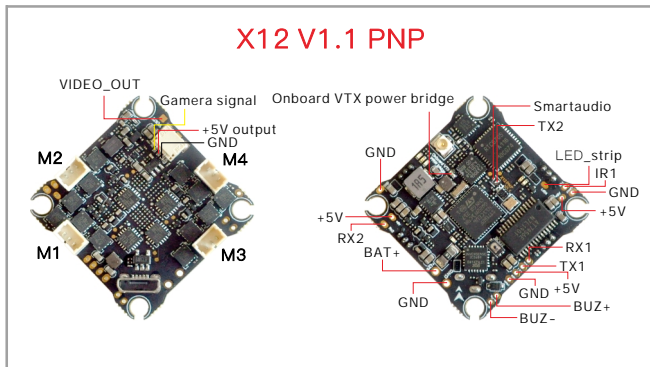
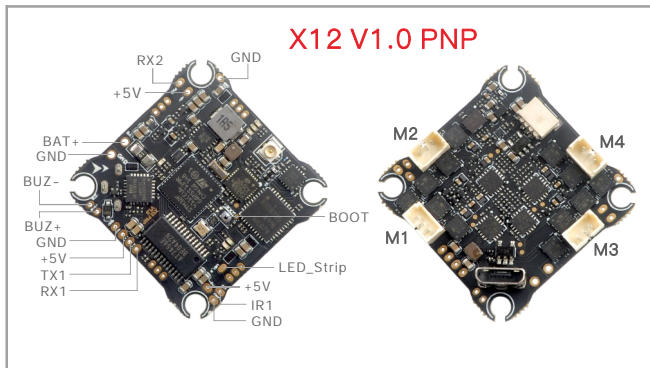

Basline 2S PNP version



### RECEIVER WIRING DIAGRAM AND SETTINGS

Identifier	Configuration/MSP	Serial Rx	Telemetry Output	Sensor Input	Peripherals
USB VCP	115200	Disabled	AUTO	Disabled	AUTO
UART1	115200	Enabled	Disabled	AUTO	Disabled
UART2	115200	Disabled	Disabled	AUTO	VTX (TBS Sm)

\*RX1/TX1/+5V/GND pads could be used for External Serial Based RX like ELRS Receiver ,TBS Tracer or CRSF Nano

\*IR1/+5V/GND pads could be used for External SBUS receiver like XM/XM+/AC900/RXSR

\*Need to enable Serial RX for UART1 and select correct receiver protocol

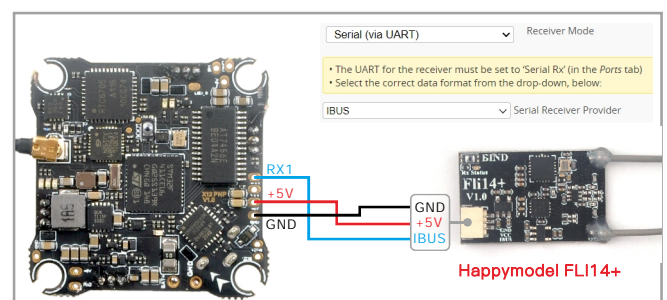
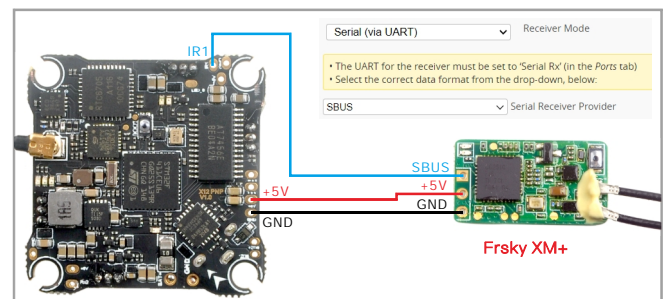
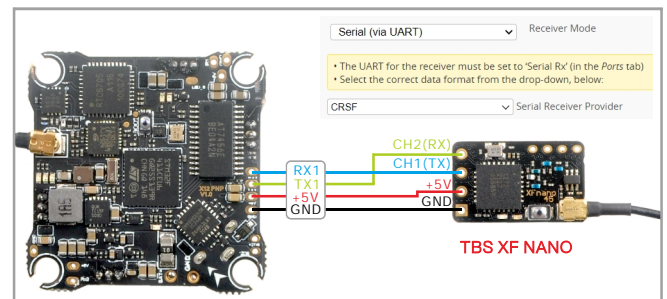
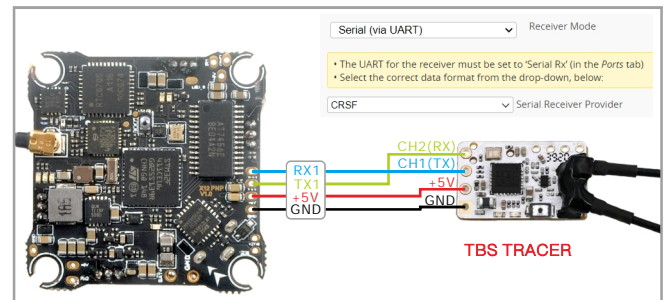
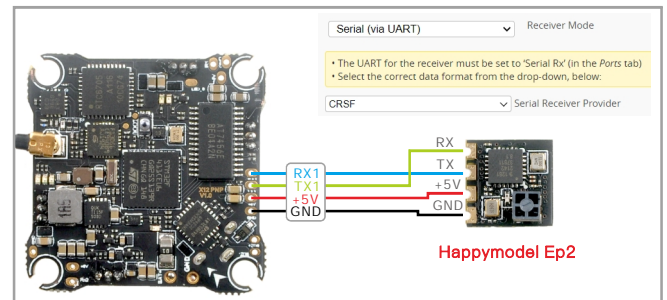

**VOLTAGE AND CURRENTS METER SETTINGS**

Voltage Meter

Battery: 0.6 V

Scale: 110

Divider Value: 10

Multiplier Value: 1

---

Amperage Meter

Battery: 0.00 A

Scale [1/10th mA/A]: 470

Offset [mA]: 0

**DEFAULT PID AND FILTER SETTINGS**

Basic/Acro	Proportional	Integral	D Max	Derivative	Feedforward
ROLL	53	95	46	43	143
PITCH	56	100	52	48	149
YAW	53	95	0	0	143

Mode:	RPY	Low	Default	High
Damping: D Gains	1.2	[Slider]		
Tracking: P & I Gains	1	[Slider]		
Stick Response: FF Gains	1	[Slider]		
Dynamic Damping: D Max	0.2	[Slider]		
Drift - Wobble: I Gains	1	[Slider]		
Pitch Damping: Pitch:Roll D	1	[Slider]		
Pitch Tracking: Pitch:Roll P, I & FF	1	[Slider]		
Master Multiplier:	1.2	[Slider]		

More Filtering

Gyro Filter Multiplier: 1

D Term Filter Multiplier: 1

---

Profile independent Filter Settings

Gyro Lowpass Filters: ON

Gyro Lowpass 1: Mode DYNAMIC, Min Cutoff Frequency 250, Max Cutoff Frequency 500, Filter Type PT1

Gyro Lowpass 2: Mode DYNAMIC, Min Cutoff Frequency 500, Max Cutoff Frequency 500, Filter Type PT1

Gyro Notch Filters: 2

Gyro RPM Filter: Mode DYNAMIC, Gyro RPM Filter Harmonics Number 3, Gyro RPM Filter Min Frequency 200

Dynamic Notch Filter: Mode DYNAMIC, Notch Count 3, Q factor 500, Min Frequency 150, Max Frequency 600

---

Default Filtering

Gyro Filter Multiplier: 1

D Term Filter Multiplier: 1

---

Profile dependent Filter Settings

D Term Lowpass 1: Mode DYNAMIC, Min Cutoff Frequency 75, Max Cutoff Frequency 150, Dynamic Curve Expo 5, Filter Type PT1

D Term Lowpass 2: Mode DYNAMIC, Min Cutoff Frequency 150, Max Cutoff Frequency 150, Dynamic Curve Expo 5, Filter Type PT1

D Term Notch Filter: 2

Yaw Lowpass Filter: Mode DYNAMIC, Min Cutoff Frequency 100

**BOARD AND SENSOR ALIGNMENT AND FREQUENCY SETTINGS**

Board and Sensor Alignment

Roll Degrees: 0, Pitch Degrees: 0, Yaw Degrees: 0

First: GYRO/ACCEL, CW 90°, First GYRO

Default: MAG Alignment

8.00 kHz Gyro update frequency

2.00 kHz PID loop frequency Recommend 2.00kHz for a better and stable experience.

**MOTORS AND ESC SETTINGS**

Mixer

Quad X

PROP OUT :Mount 2023 propeller on #1 and #4 motors, Mount 2023R propeller on #2 and #3 motors

Motor direction is reversed: ON

---

ESC/Motor Features

DSHOT300 ESC/Motor protocol

MOTOR\_STOP: Don't spin the motors when armed

ESC\_SENSOR: Use KISS/BLHeli\_32 ESC telemetry over a separate wire

Bidirectional DShot (requires supported ESC firmware)

Motor Idle (% static): 10

**BLUJAY ESC SETTINGS**

Common Parameters

Minimum Startup Power (Boost): 1100

Maximum Startup Power (Protection): 1200

Temperature Protection: 140 C

Motor Timing: 22.5° (MediumHigh)

Demag Compensation: Low

RPM Power Protection (Rampup): 9x

When using Bluejay ESC firmware, the startup power should set like the picture shows.

**VTX BANDS AND CHANNELS SETUP**

Frequency and channel frequency table:

FR	CH	CH1	CH2	CH3	CH4	CH5	CH6	CH7	CH8
BOSCAM_A	5865M	5845M	5825M	5805M	5785M	5765M	5745M	5725M	
BOSCAM_B	5733M	5752M	5771M	5790M	5809M	5828M	5847M	5866M	
BOSCAM_E	5705M	5685M	5665M	5645M	5885M	5905M	5925M	5945M	
FATSHARK	5740M	5760M	5780M	5800M	5820M	5840M	5860M	5880M	
RACEBAND	5658M	5695M	5732M	5769M	5806M	5843M	5880M	5917M	
LOWRACE	5333M	5373M	5413M	5453M	5493M	5533M	5573M	5613M	

There are 2 ways to switch the vtx channels:

Identifier	Configuration/MSP	Serial Rx	Telemetry Output	Sensor Input	Peripherals
USB VCP	ON 115200	ON	Disabled AUTO	Disabled AUTO	Disabled AUTO
UART1	ON 115200	ON	Disabled AUTO	Disabled AUTO	Disabled AUTO
UART2	ON 115200	ON	Disabled AUTO	Disabled AUTO	TBS SmartAux AUTO

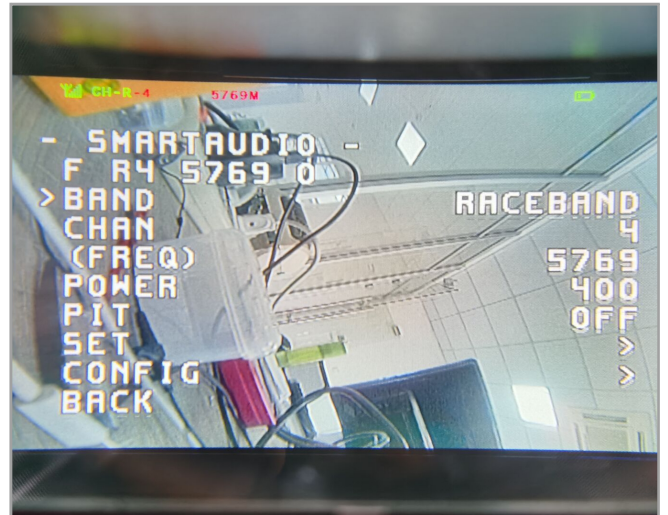

1. Plug USB to Mobula8 1-2S Flysky then we should Go to Betaflight CLI type the command  
Set vtx\_band=5  
Set vtx\_channel=4  
save  
This command will change the vtx channel to 5769
2. Disarm the Mobula8 1-2S Flysky and then move the stick of the transmitter THR MID YAW LEFT PITCH UP to enter OSD Menu Enter to Features then enter to VTX SA to set VTX Band and channel

**FLIGHT CONTROLLER FIRMWARE UPDATE**

1. Install latest STM32 Virtual COM Port Driver <http://www.st.com/web/en/catalog/tools/PF257938>
2. Install STM BOOTLOAD Driver (STM Device in DFU MODE)
3. Open Betaflight configurator and choose firmware target "CRAZYBEEF4DX", then select the firmware version.
4. There are 2 ways to get in DFU Mode: 1). solder the boot pad and then plug USB to computer 2). loading betaflight firmware and hit "flash", then it will getting into DFU Mode automatically.
5. Open Zadig tools to replace the drivers from STM32 Bootloader to WINUSB Driver.
6. Reconnect the flight controller to the computer after replace driver done, and open Betaflight Configurator, loading firmware and flash.

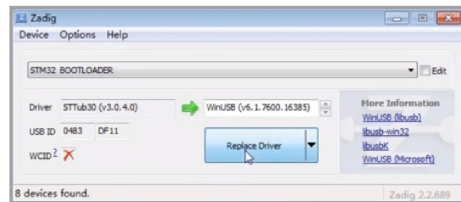

Firmware and diff download